

FRONT VIEW

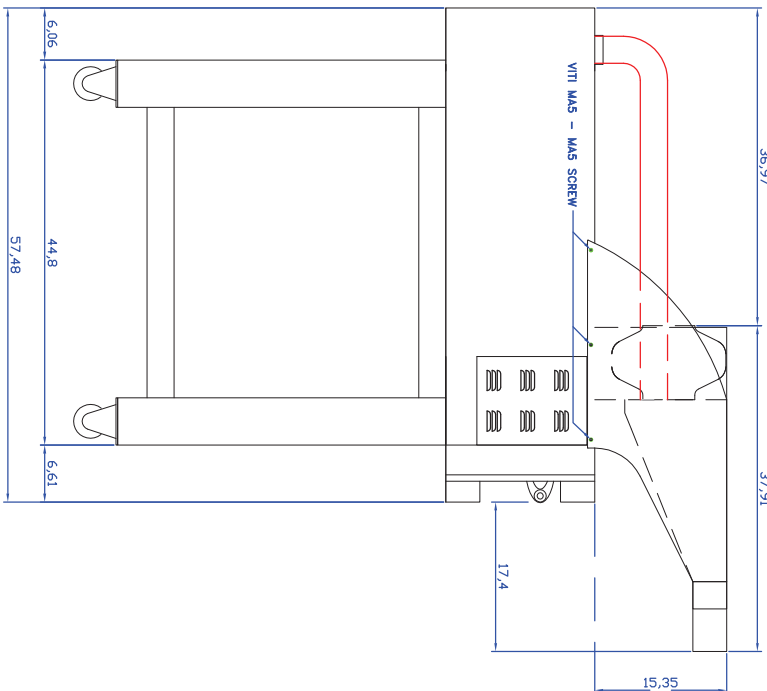

SIDE VIEW

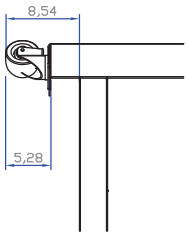

OPTIONAL (WHEELS)

Note: measurement are in inches



Descrizione: <b>Installation plan - Front and side</b>		Scatatura: <b>It</b>
Prodotto: <b>Oven series MICHELANGELO 935/1</b>		Scatatura dal:
1	0 2/1/0/2016 F.Veronese F.Veronese F.Cuppone Primo emissione	
2		
Ni	Dato	Esecuz.
	Verifica	Approvaz.
Descrizione		

Note: QUESTO DISSEGNO E' DI ESCLUSIVA PROPRIETA' DELLA DITTA CUPPONE FILII SRL

Form. orig.: <b>A3</b>
Scale: <b>1:10</b>
Dis. N.: <b>161021AR00</b>
Autore.: <b>VRN</b>
Nome file: <b>161021AR00</b>

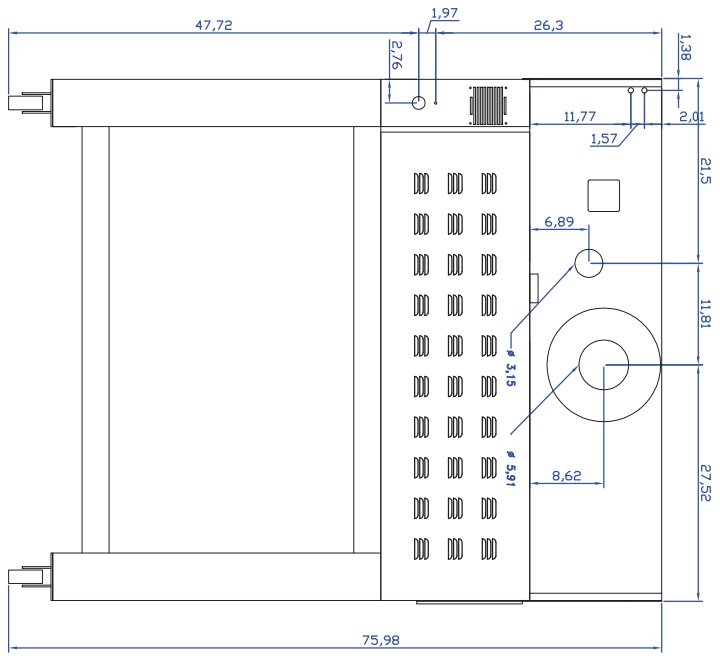

BACK VIEW

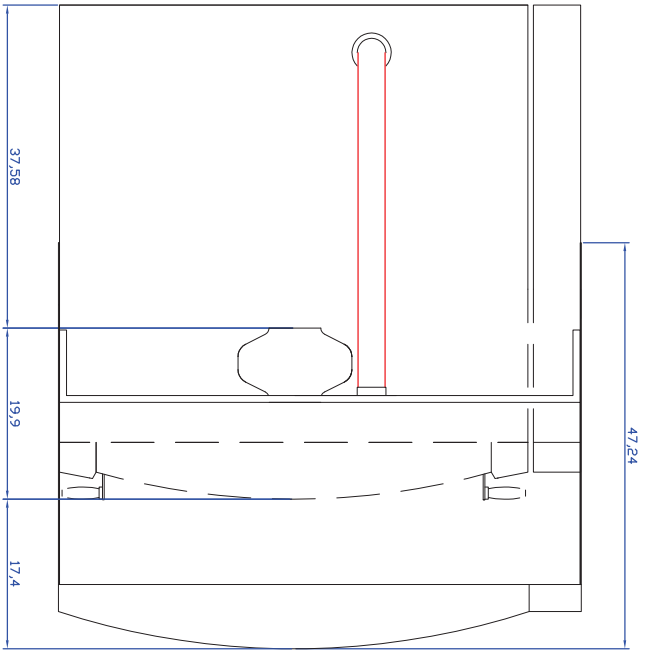

PLANT WITH HOOD

Note: measurement are in inches



Descrizione: <b>Installation plan - Back and plant</b>		Scatolucce it:
Prodotto: <b>Oven series MICHELANGELO 935/1</b>		Scatolucce dal:
1	0 2/1/2016 F. Veronesi F. Veronesi F. Cuppone Primo emissione	
2		
Ni	Data	Descrizione
	Esecuz:	Verifica
	Approvaz:	

Note: QUESTO DISGNO E' DI ESCLUSIVA PROPRIETA' DELLA DITTA CUPPONE FILII SRL

Form. orig.:	A3
Scale:	1:10
Ds. N.:	161021AR00
Autore:	VRN
Nome file:	161021AR00

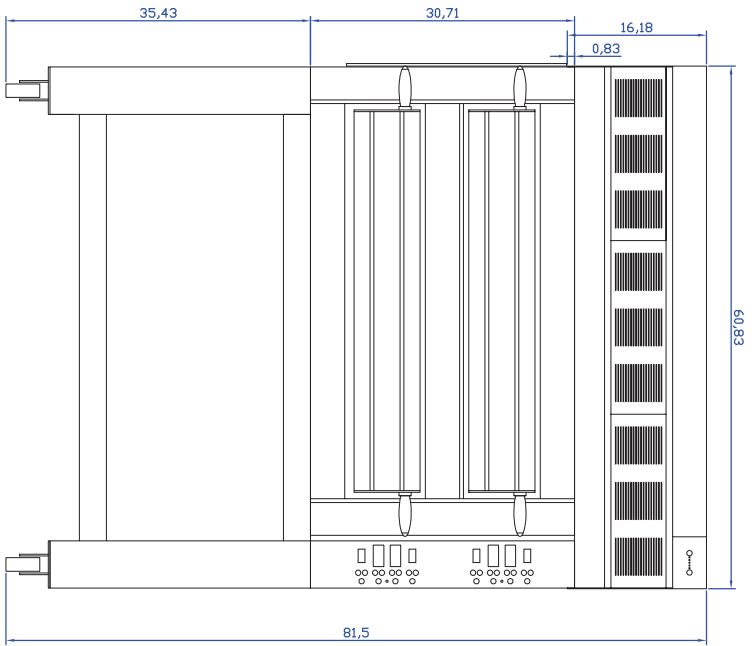

FRONT VIEW

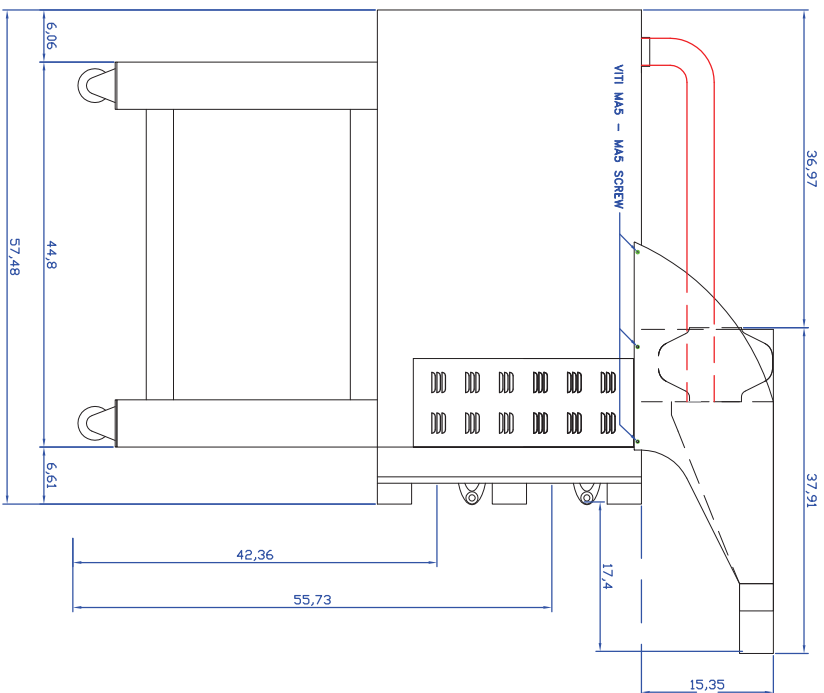

SIDE VIEW

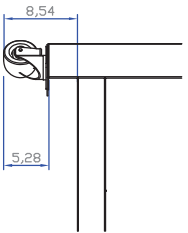

OPTIONAL (WHEELS)

Note: measurement are in inches



Descrizione: <b>Installation plan - Front and side</b>		Scrittore: It:
Prodotto: <b>Oven series MICHELANGELO 935/2</b>		Scrittore dat:
1	0 2/10/2016 F. Veronesi F. Veronesi F. Cuppone	Primo emissione
2		
Ni	Data	Esecuz:
		Verifica
		Approvaz:
		Descrizione

Note: QUESTO DISSEGNO E' DI ESCLUSIVA PROPRIETA' DELLA DITTA CUPPONE FILII SRL

Form. orig.:	A3
Scale:	1:10
Dis. N.:	161021BR00
Autore:	VRN
Nome file:	161021BR00

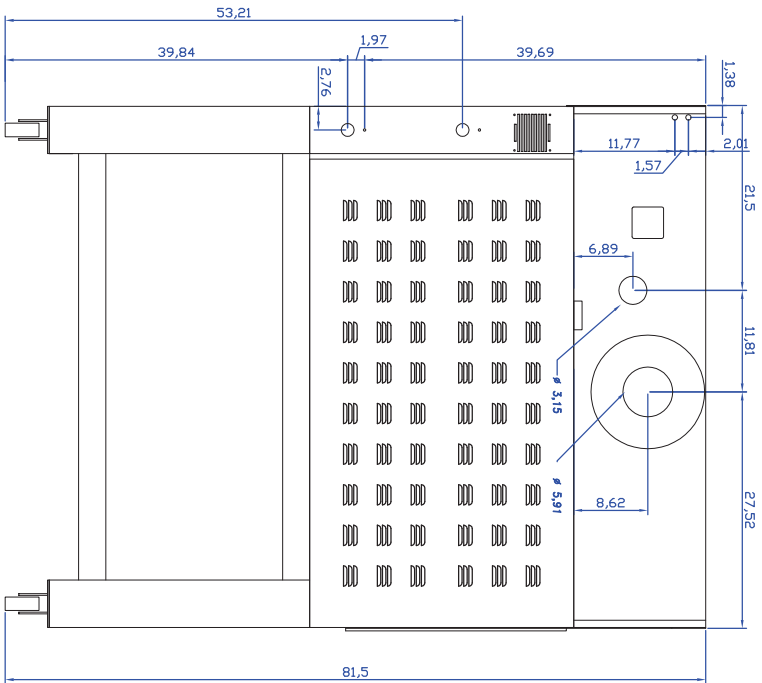

BACK VIEW

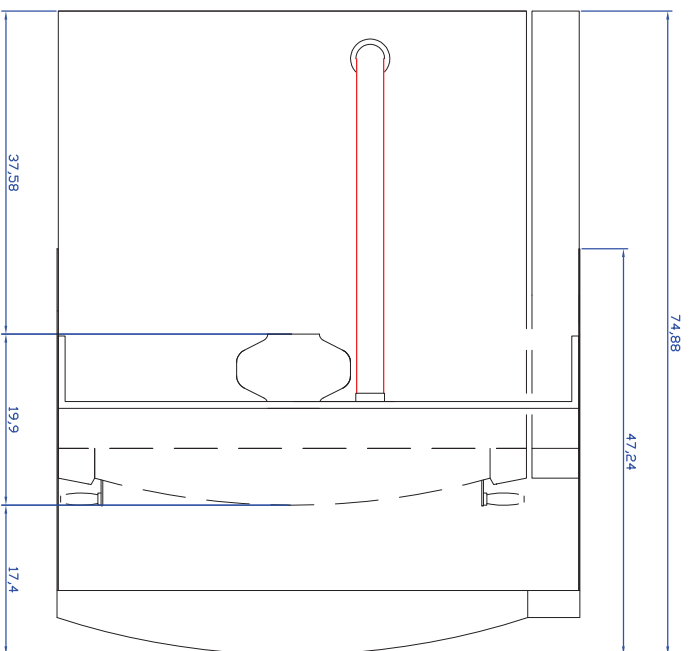

PLANT WITH HOOD

Note: measurement are in inches



Descrizione: <b>Installation plan - Back and plant</b>		Sostituisce il:	
Prodotto: <b>Oven series MICHELANGELO 935/2</b>		Sostituito da:	
1	0 2/1/0/2016 F.Veronesi F.Veronesi F.Cuppone	Primo emissione	
2	1	Verifica	
Data		Esecuz.	
N°		Approvaz.	
		Descrizione	

Note: QUESTO DISSEGNO E' DI ESCLUSIVA PROPRIETA' DELLA DITTA CUPPONE FILII SRL

Form. orig.: <b>A3</b>
Scale: <b>1:10</b>
Dis. N.: <b>161021BR00</b>
Autore: <b>VRN</b>
Nome file: <b>161021BR00</b>

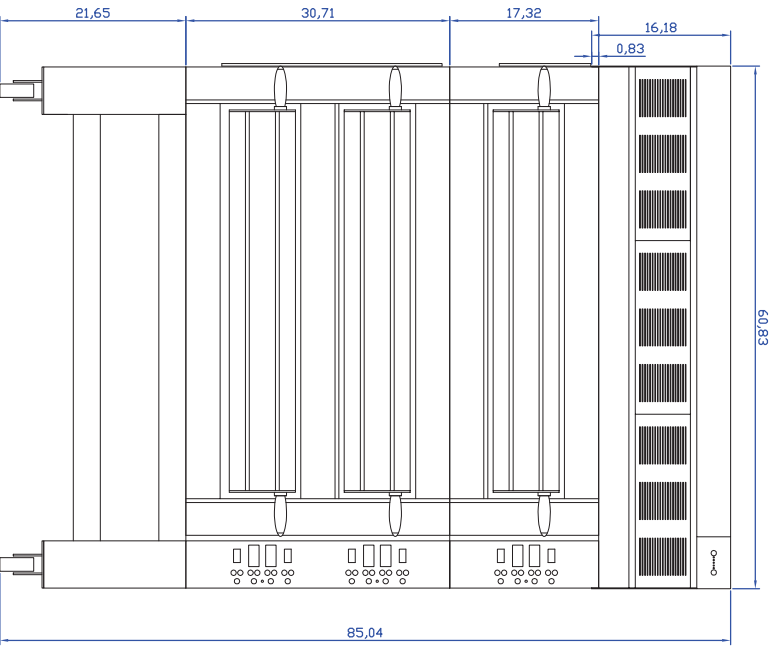

FRONT VIEW

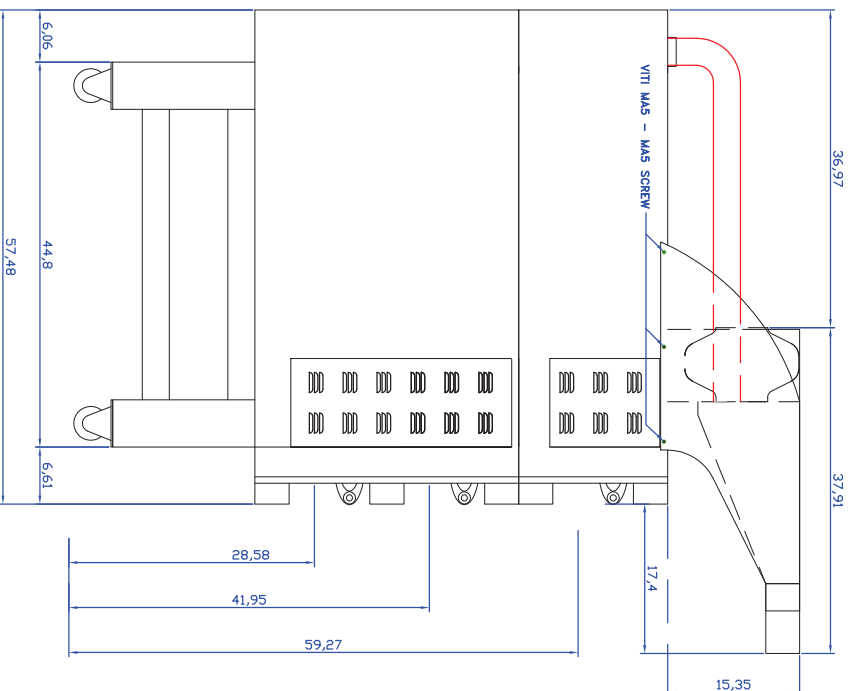

SIDE VIEW

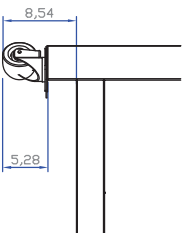

OPTIONAL (WHEELS)

Note: measurement are in inches



Descrizione: Installation plan - Front and side		Scrittorese it:	
Prodotto: Oven series MICHELANGELO 935/3		Scrittorese dat:	
1	0 2/10/2016 F. Veronesi F. Veronesi F. Cuppone	Primo emissione	
2	0 2/10/2016 F. Veronesi F. Veronesi F. Cuppone	Primo emissione	
Ni	Descrizione		

Note: QUESTO DISEGNO E' DI ESCLUSIVA PROPRIETA' DELLA DITTA CUPPONE FILII SRL

Form. orig.: A3
Scale: 1:10
Dis. N.: 161021CR00
Autore: VRN
Nome file: 161021CR00

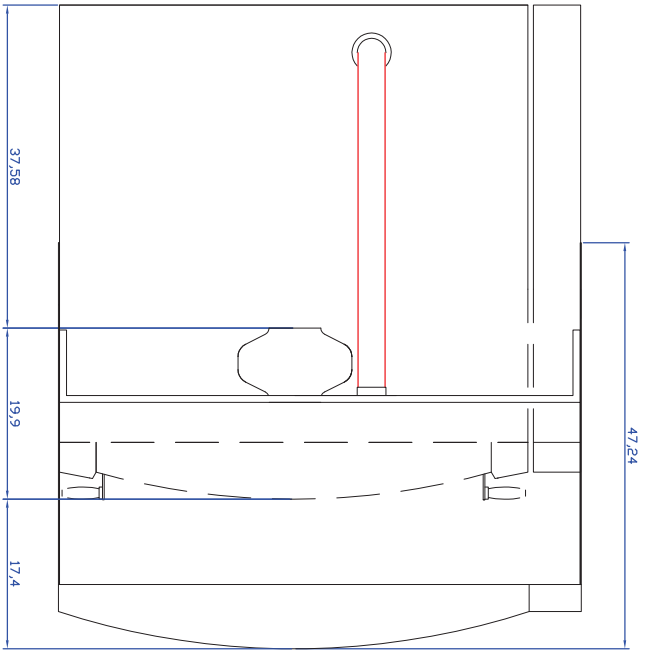
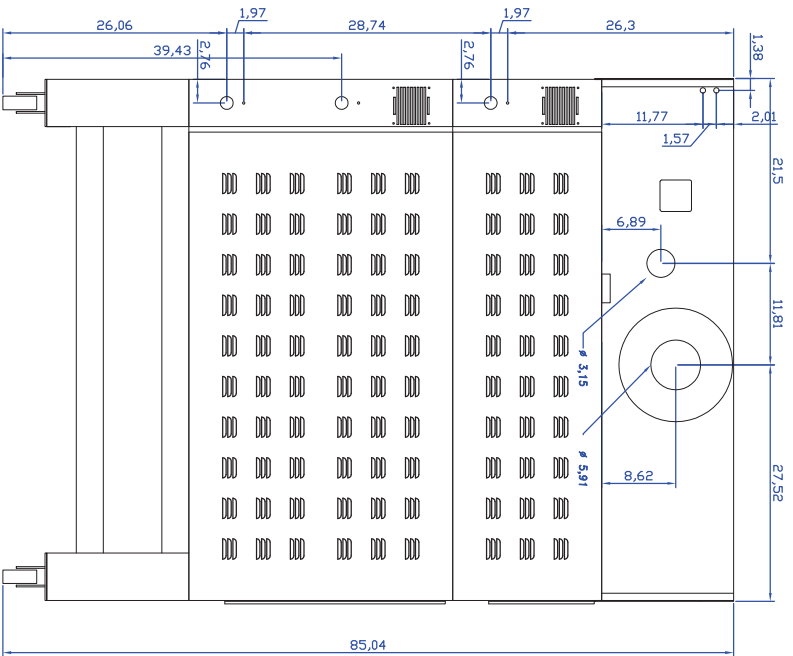

BACK VIEW

Note: measurement are in inches



Descrizione: <b>Installation plan - Back and plant</b>		Sostituzione di:	
Prodotto: <b>Oven series MICHELANGELO 935/3</b>		Sostituito da:	
1	0 2/1/0/2016 F. Veronesi F. Veronesi F. Cuppone	Primo emissione	
2	1		
Ni	Data	Esecuz:	Verifica
		Approvaz:	Descrizione

Note: QUESTO DISSEGNO E' DI ESCLUSIVA PROPRIETA' DELLA DITTA CUPPONE FILII SRL

Form. orig.:	A3
Scale:	1:10
Dis. N.:	161021CR00
Autore:	VRN
Nome file:	161021CR00