

Note: measurement are in inches

		Descrizione: Installation plan – Front and side		Sostituisce il:	
Prodotto: Oven series DONATELLO 935/1		Sostituito da:		Form. orig.: A3	
2		1		Scale: 1:10	
0 10/04/2014 F.Veronese F.Veronese F.Cuppone Prima emissione		N° Data Esecuz. Verifica Approvaz. Descrizione		Dis. N.: 160113AR00	
Note: QUESTO DISEGNO E' DI ESCLUSIVA PROPRIETA' DELLA DITTA CUPPONE F.LLI SRL		Autore.: VRN		Norme file: 140410CR00	

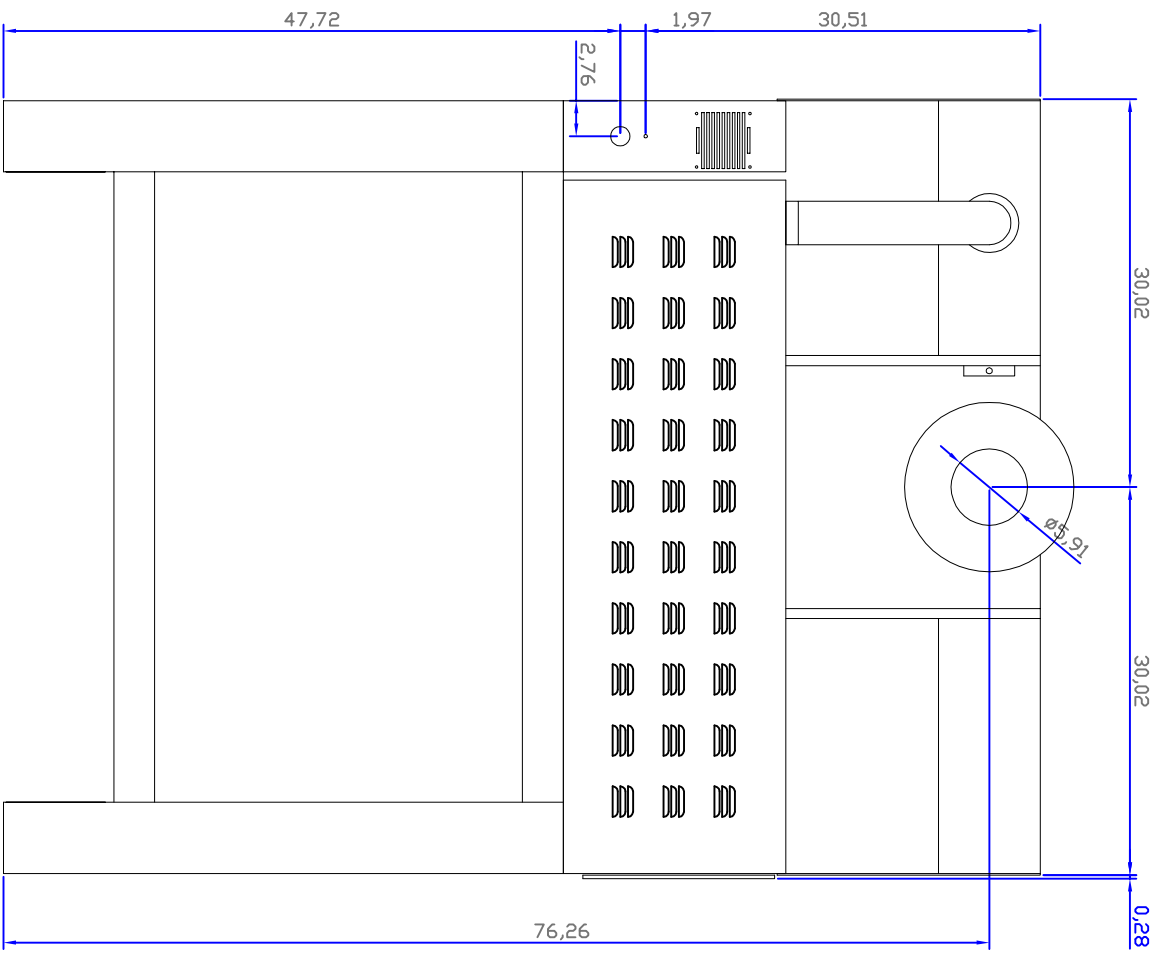

BACK VIEW

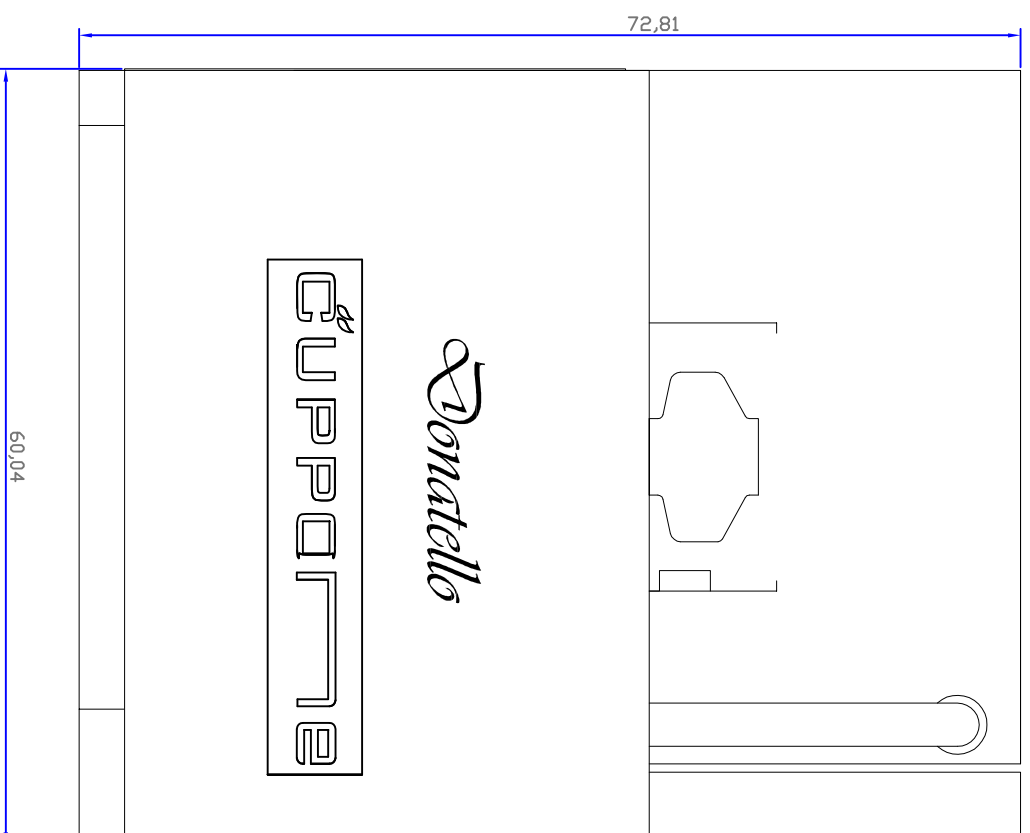

PLANT WITH HOOD

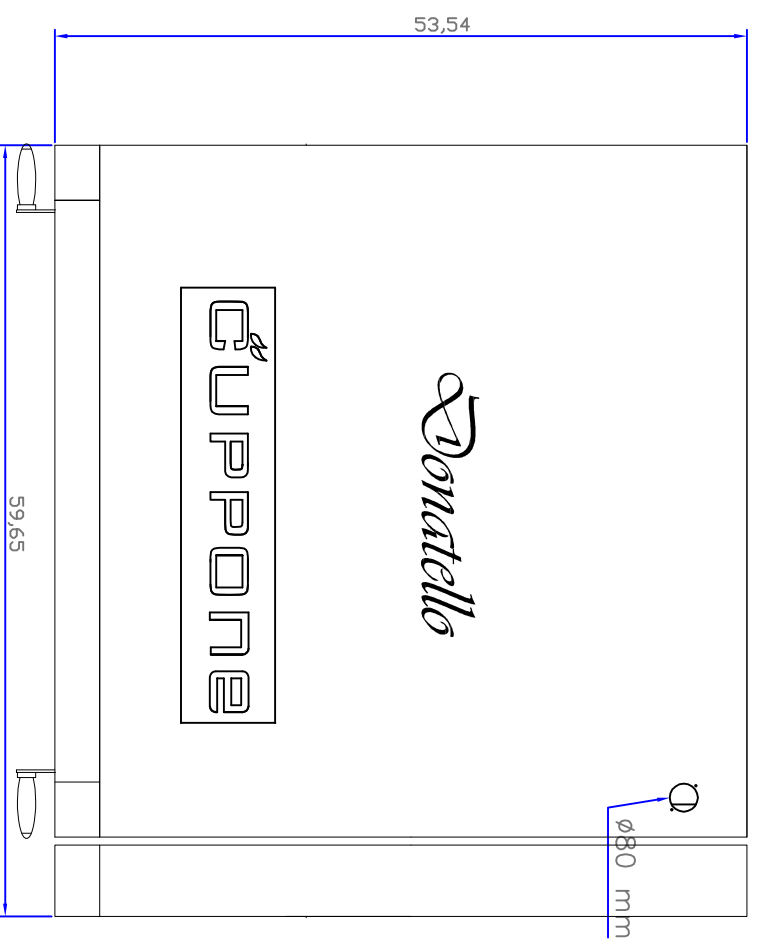

PLANT

Note: measurement are in inches



Descrizione: Installation plan – Back and plant		Sostituisce il:
Prodotto: Oven series DONATELLO 935/1		Sostituito da:
2		
1		
0	10/04/2014	F.Veronese F.Veronese F.Cuppone
N°	Data	Esecuz. Verifica Approvaz. Prima emissione
Descrizione		

Note: QUESTO DISEGNO E' DI ESCLUSIVA PROPRIETA' DELLA DITTA CUPPONE F.LLI SRL

Form. org.:	A3
Scale:	1:10
Dis. N.:	160113AR00
Autore.:	VRN
Nome file:	140410CR00

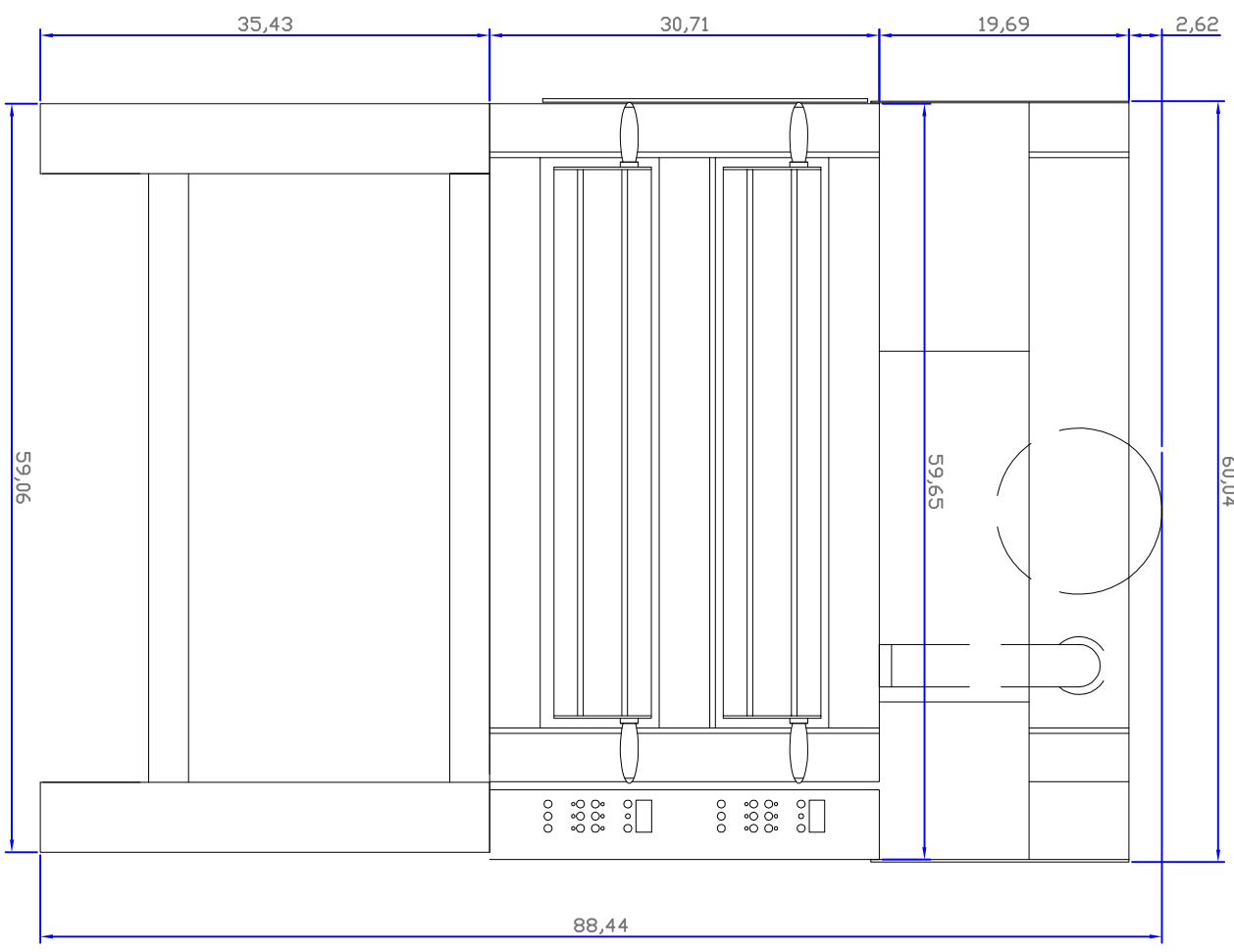

FRONT VIEW

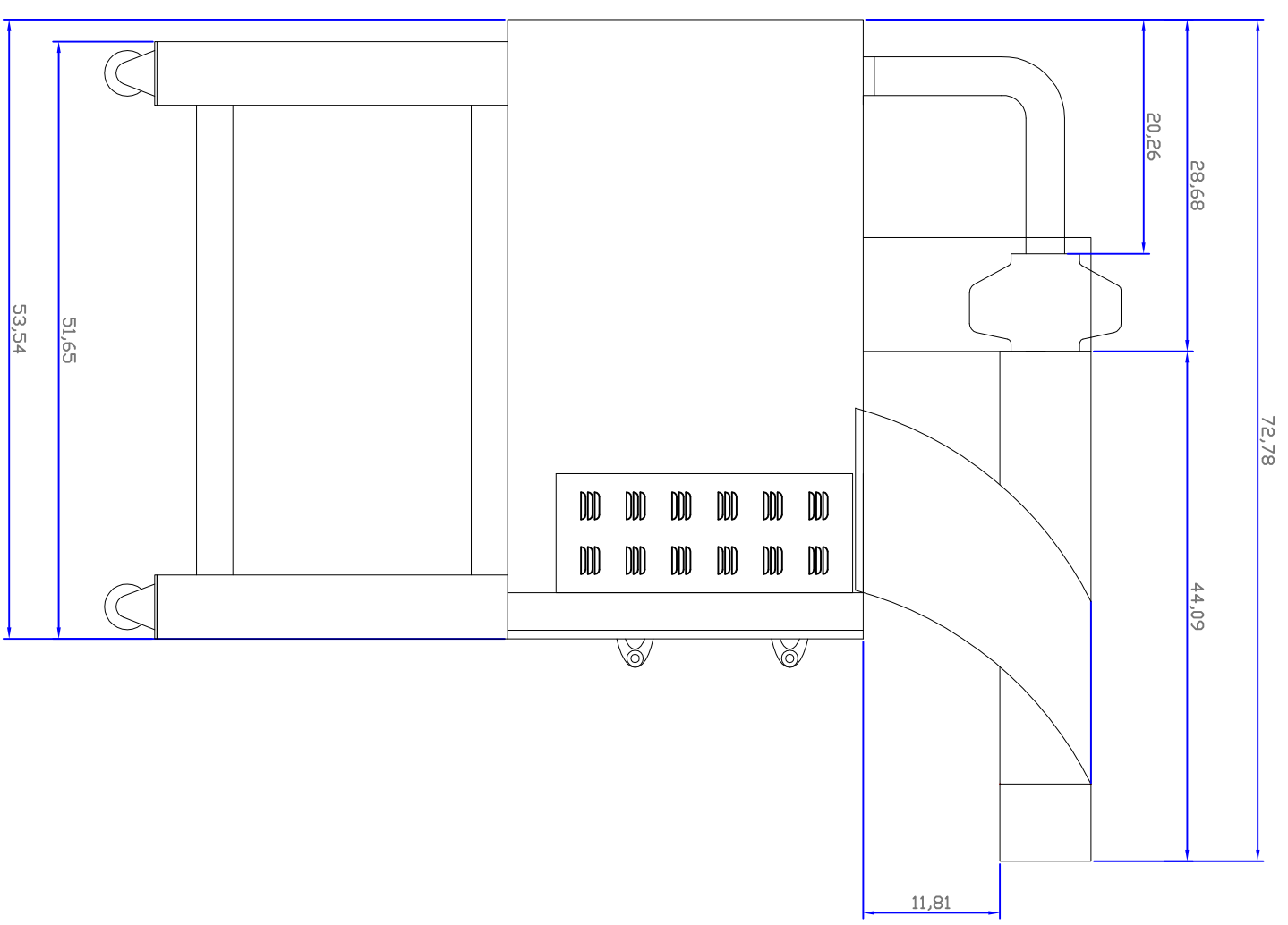

SIDE VIEW

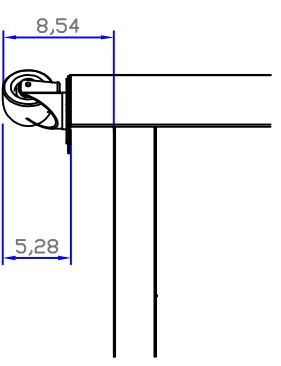

OPTIONAL (WHEELS)

Note: measurement are in inches

		Descrizione: Installation plan – Front and side		Sostituisce il:	
Prodotto: Oven series DONATELLO 935/2		Sostituito da:		Form. orig.: A3	
2		1		Scale: 1:10	
0 09/04/2014 F.Veronese F.Veronese F.Cuppone Prima emissione		N° Data Esecuz. Verifica Approvaz.		Dis. N.: 140410BR00	
N°		Descrizione		Autore.: VRN	
Note: QUESTO DISEGNO E' DI ESCLUSIVA PROPRIETA' DELLA DITTA CUPPONE F.LLI SRL		Norme file:		140409CR00	

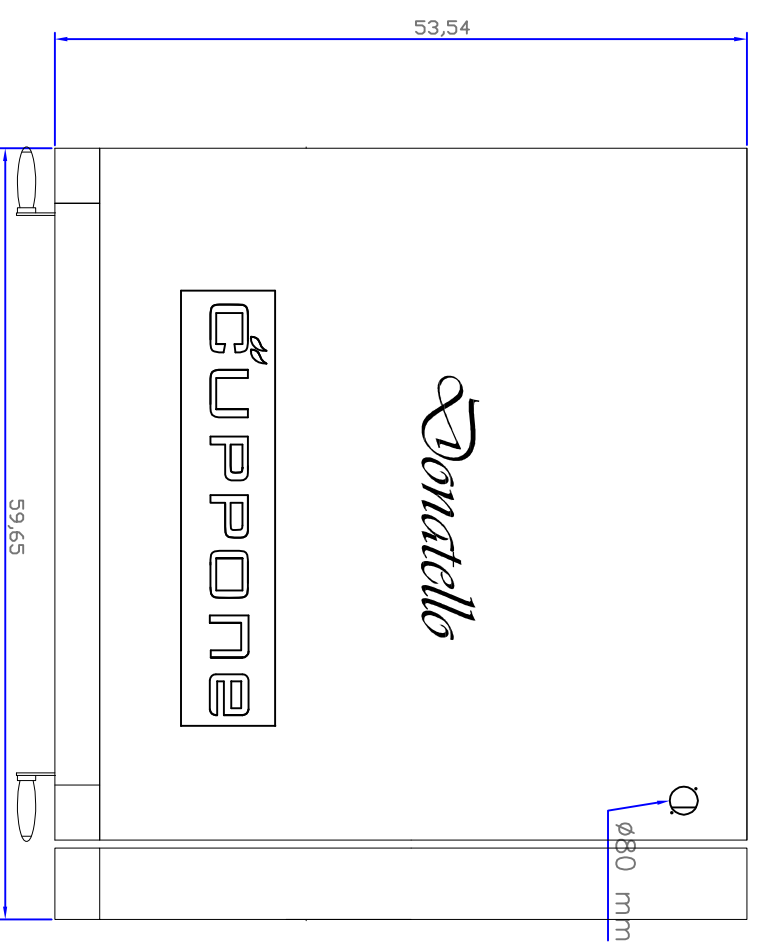
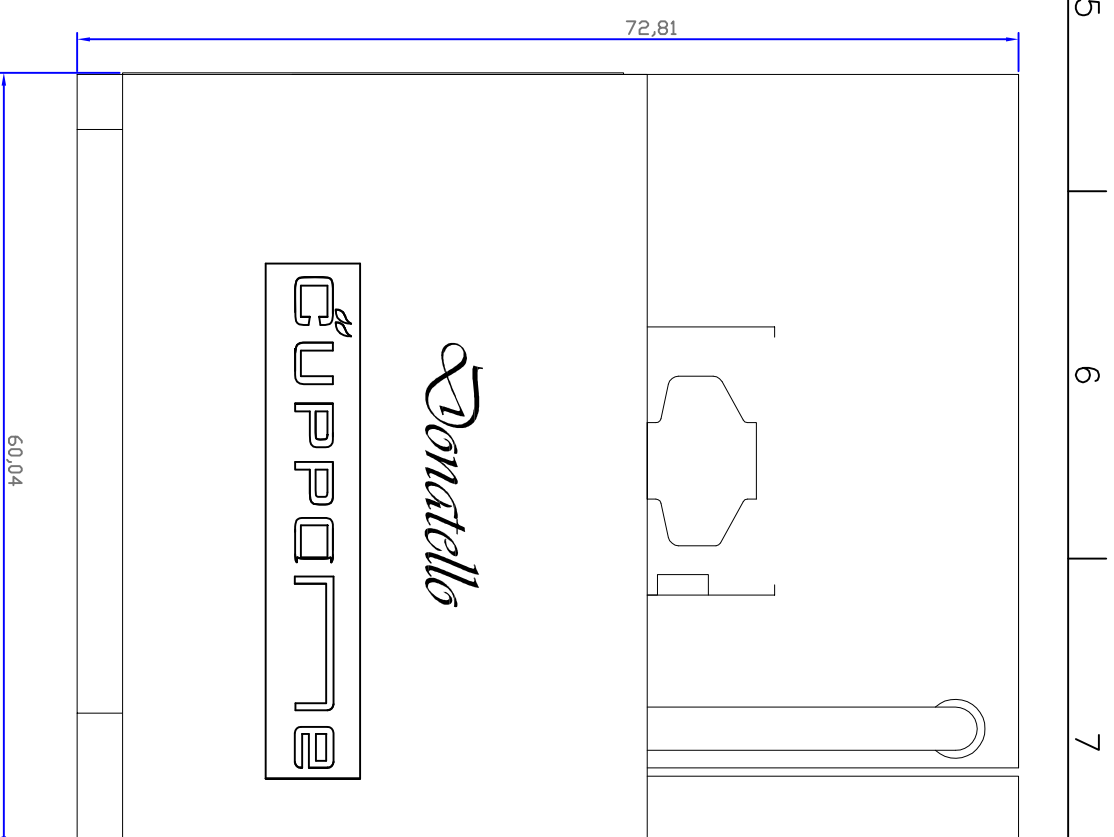
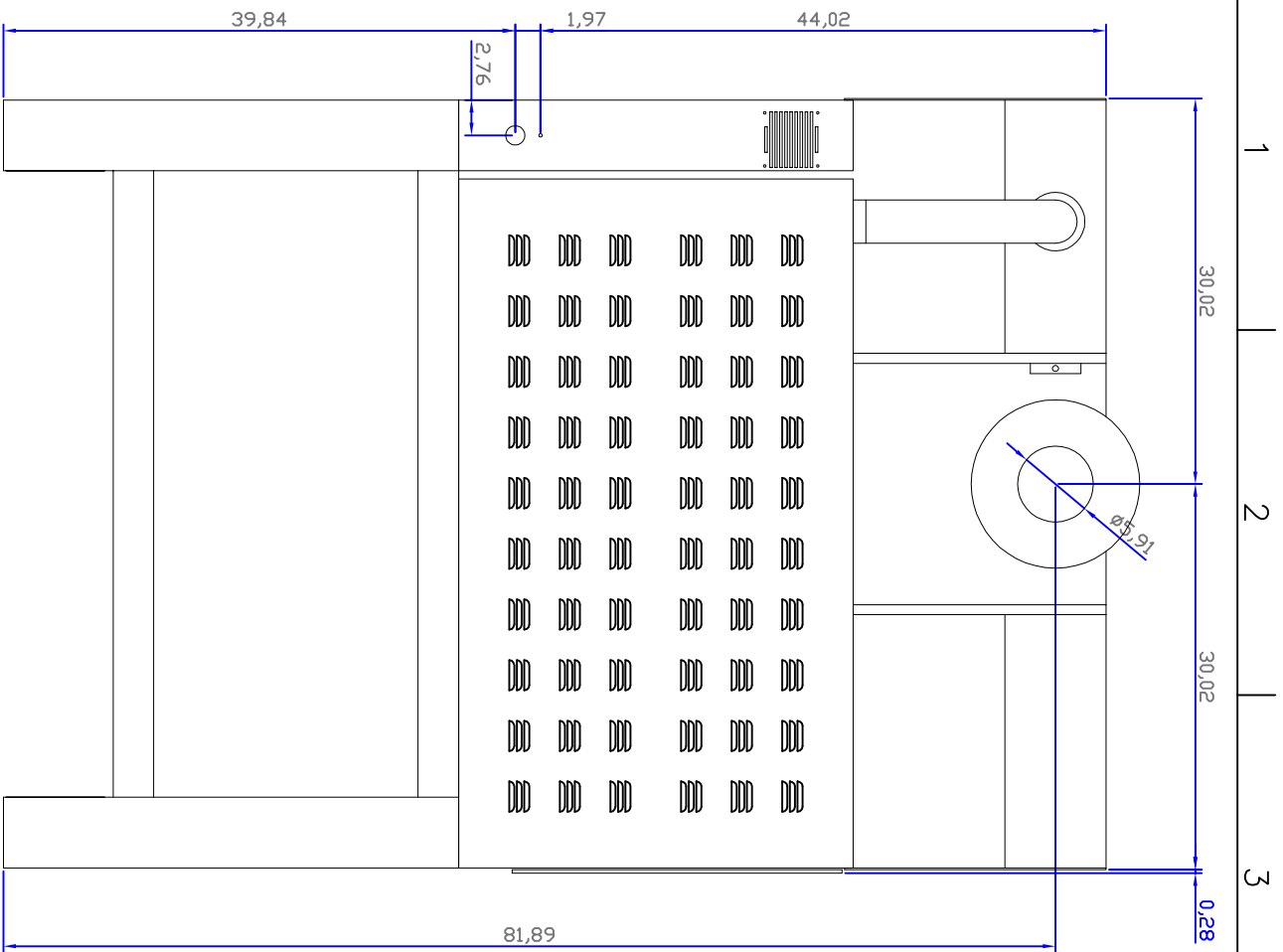

Note: measurement are in inches



Descrizione: Installation plan – Back and plant		Sostituisce il:
Prodotto: Oven series DONATELLO 935/2		Sostituito da:
2		
1		
0	09/04/2014	F.Veronese F.Veronese F.Cuppone
N°	Data	Esecuz. Verifica Approvaz. Prima emissione
Descrizione		

Note: QUESTO DISEGNO E' DI ESCLUSIVA PROPRIETA' DELLA DITTA CUPPONE FILII SRL

Form. orig.:	A3
Scale:	1:10
Dis. N.:	140410BR00
Autore.:	VRN
Nome file:	140409CR00

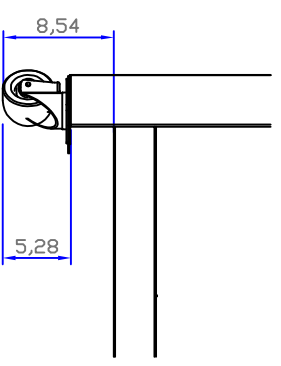
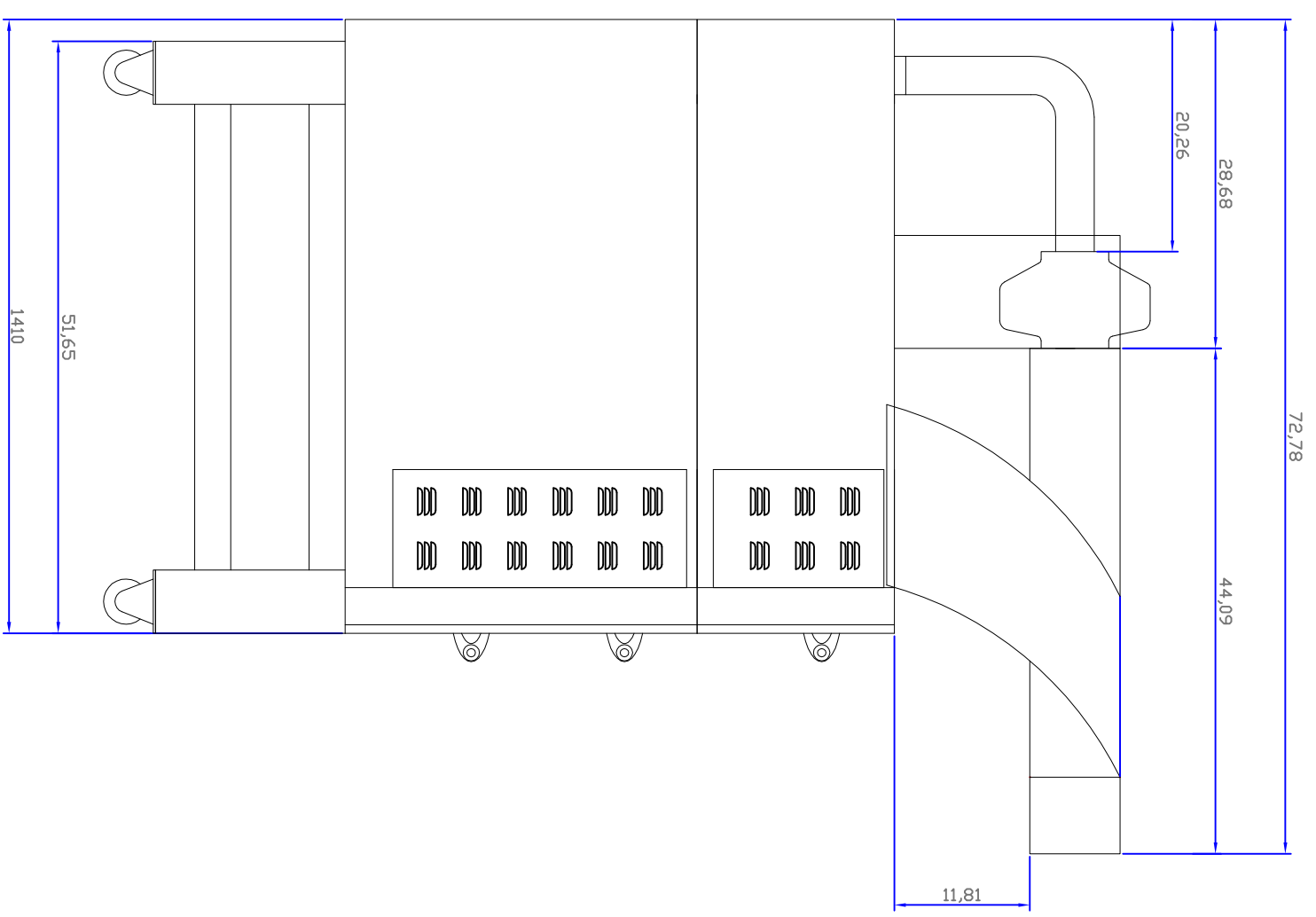
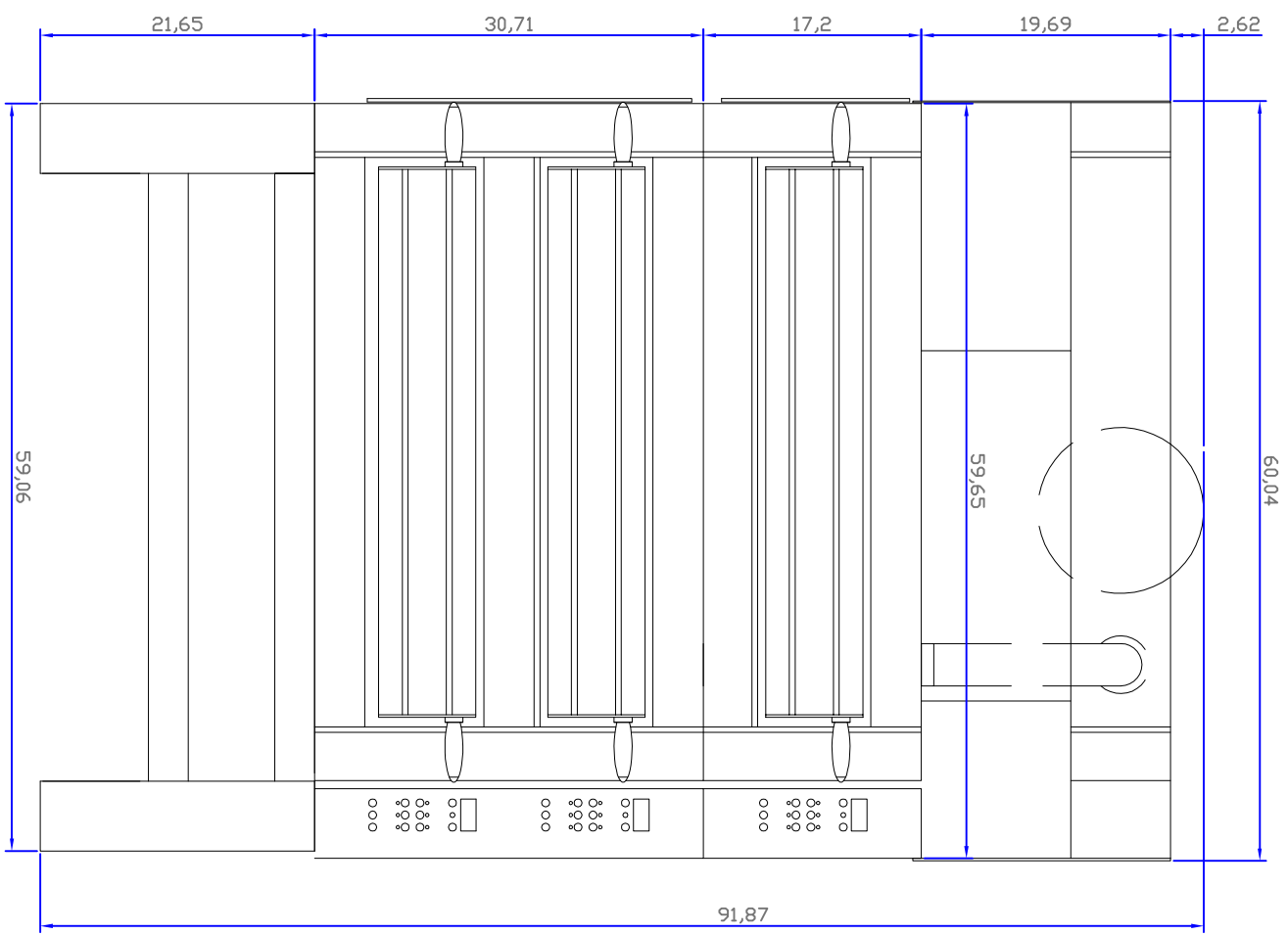

Note: measurement are in inches

		Descrizione: Installation plan – Front and side		Sostituisce il:	
Prodotto: Oven series DONATELLO 935/3				Sostituito da:	
2					
1					
0	09/04/2014	F. Veronese	F. Veronese	F. Cuppone	Prima emissione
N°	Data	Esecuz.	Verifica	Approvaz.	Descrizione
Note: QUESTO DISEGNO E' DI ESCLUSIVA PROPRIETA' DELLA DITTA CUPPONE F.LLI SRL					
Form. orig.: A3					
Scale: 1:10					
Dis. N.: 160113CR00					
Autore.: VRN					
Norme file: 140409CR00					

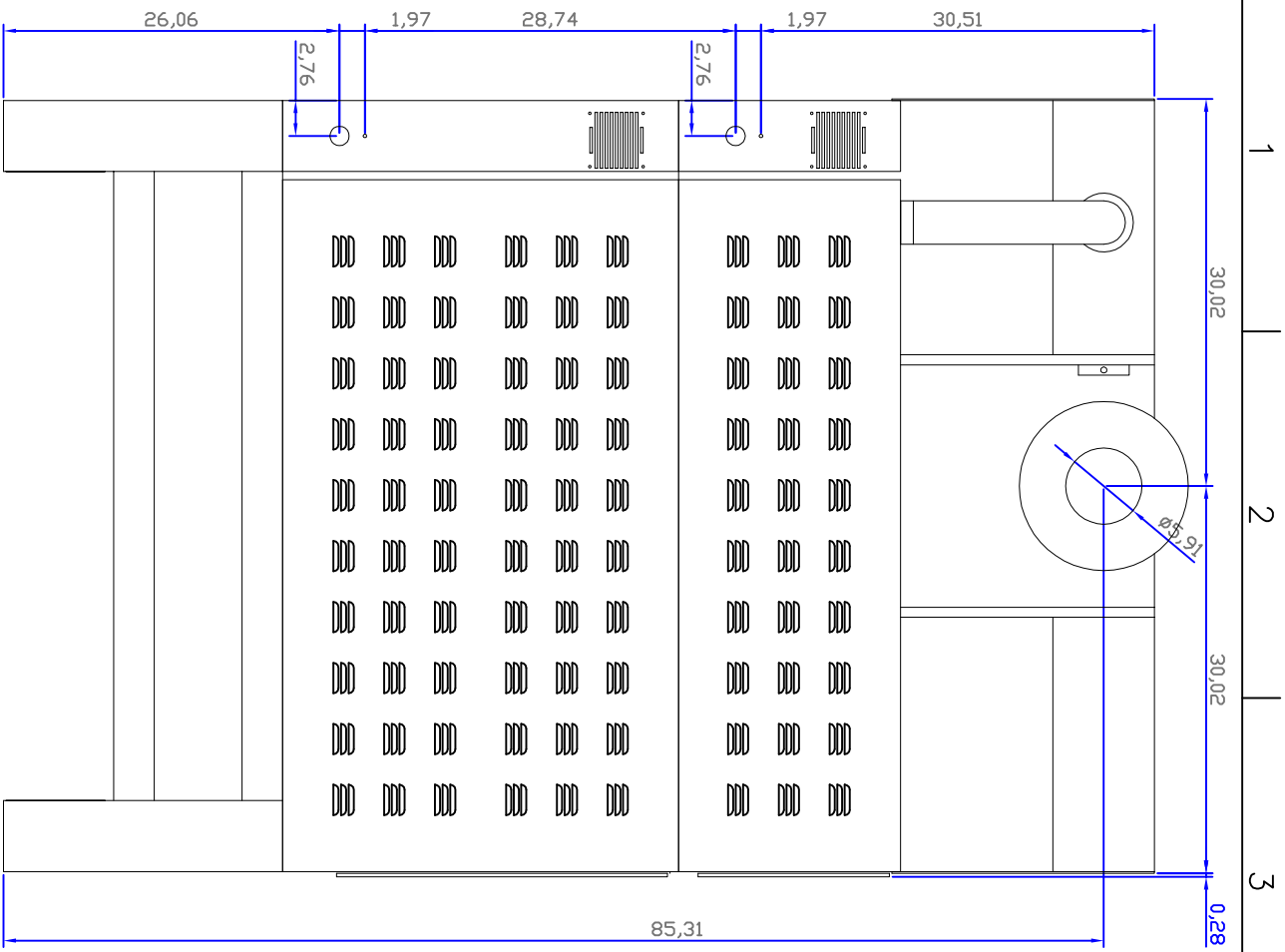

BACK VIEW

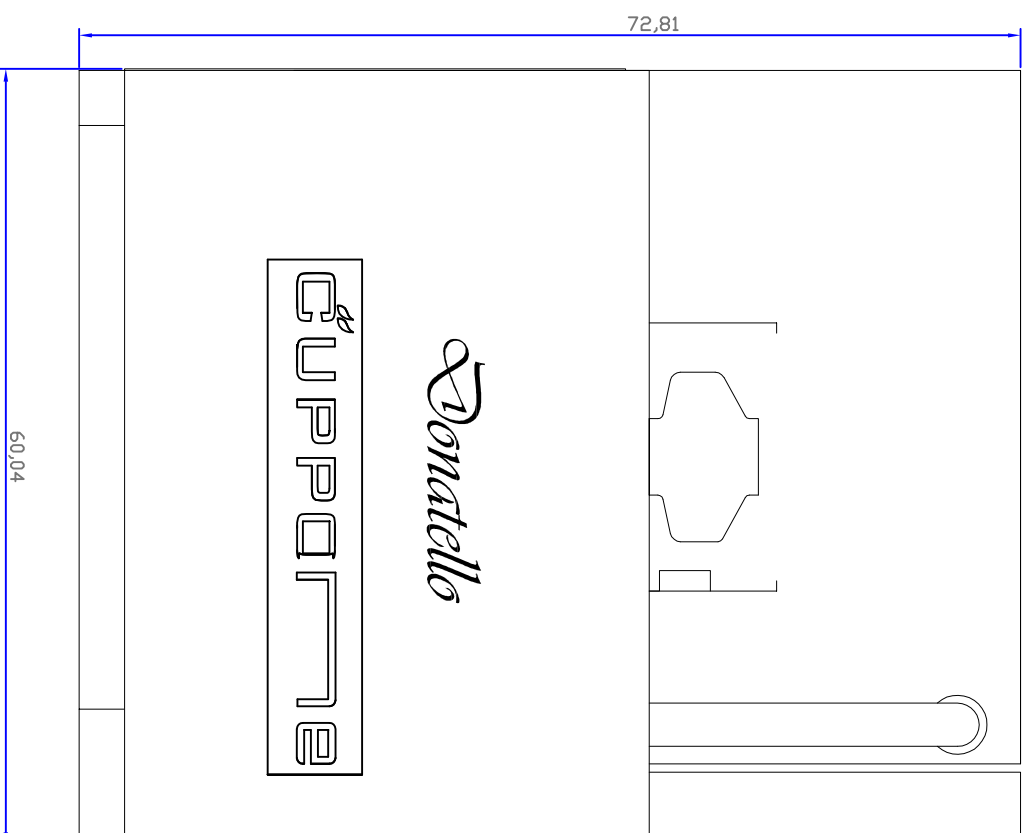

PLANT WITH HOOD

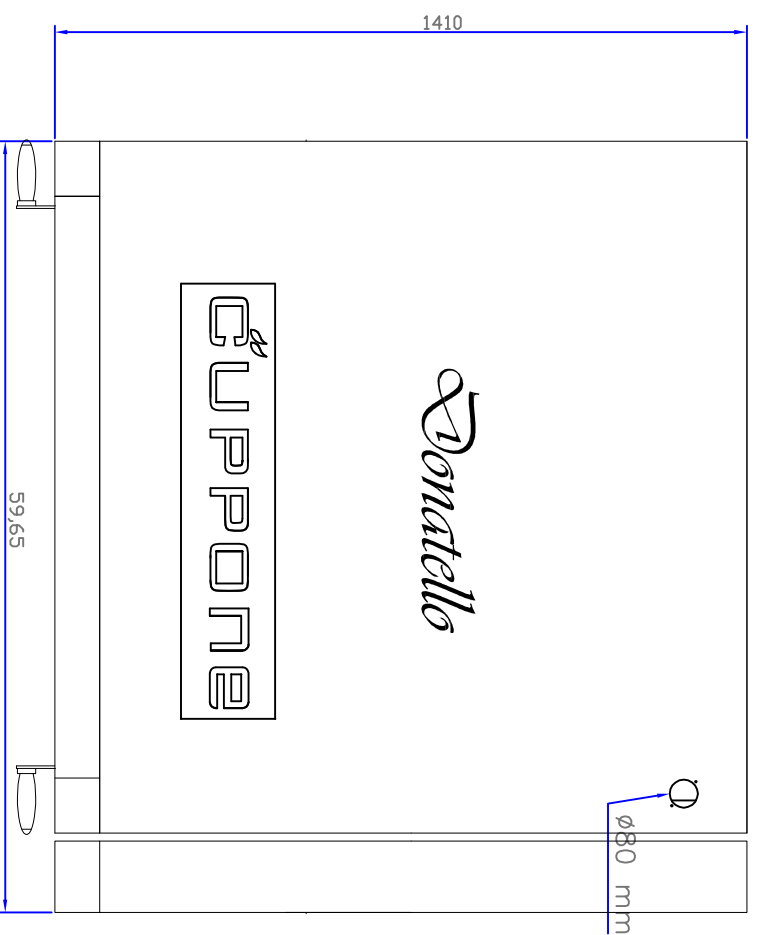

PLANT

Note: measurement are in inches



Descrizione: Installation plan – Back and plant		Sostituisce il:
Prodotto: Oven series DONATELLO 935/3		Sostituito da:
2		
1		
0	09/04/2014 F.Veronese F.Veronese F.Cuppone	Prima emissione
N°	Data	Esecuz. Verifica Approvaz. Descrizione

Note: QUESTO DISEGNO E' DI ESCLUSIVA PROPRIETA' DELLA DITTA CUPPONE FILII SRL

Form. orig.:	A3
Scale:	1:10
Dis. N.:	160113CR00
Autore.:	VRN
Nome file:	140409CR00