

FRONT VIEW

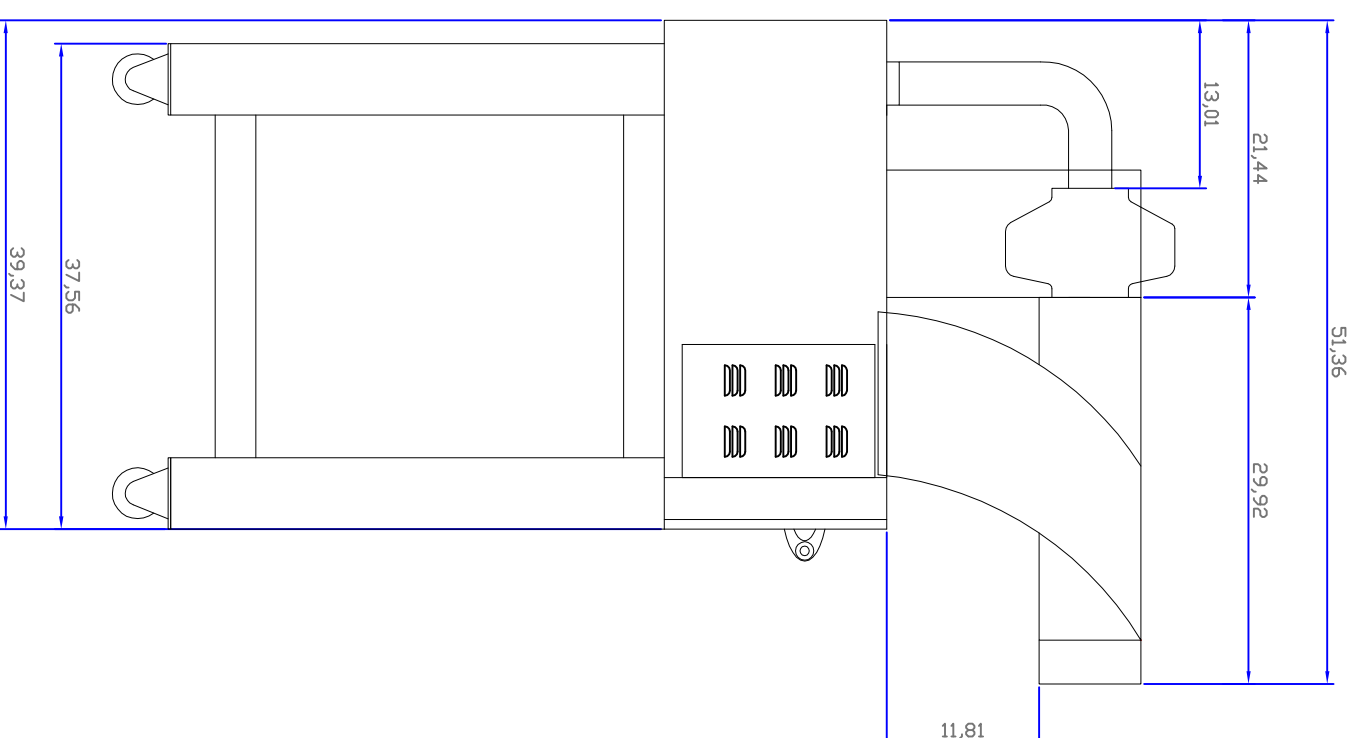

SIDE VIEW

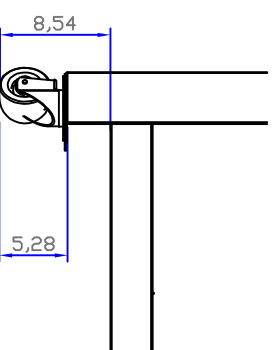

OPTIONAL (WHEELS)

Note: measurement are in inches



Descrizione: Installation plan – Front and side		Sostituisce il:
Prodotto: Oven series DONATELLO 435/1		Sostituito da:
2		
1		
0	10/04/2014	F.Veronese F.Veronese F.Cuppone
N°	Data	Esecuz. Verifica Approvaz. Descrizione
		Prima emissione

Note: QUESTO DISEGNO E' DI ESCLUSIVA PROPRIETA' DELLA DITTA CUPPONE F.LLI SRL

Form. orig.:	A3
Scale:	1:10
Dis. N.:	160113AR00
Autore.:	VRN
Nome file:	160113AR00

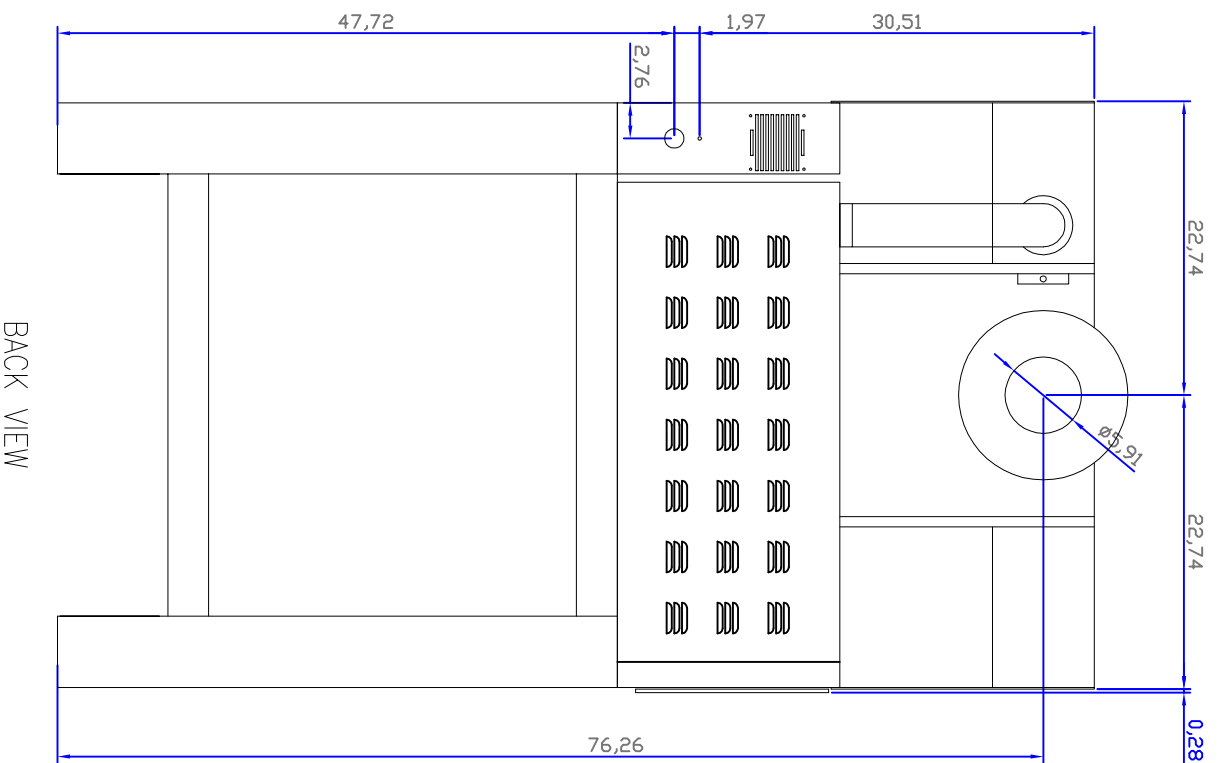

BACK VIEW

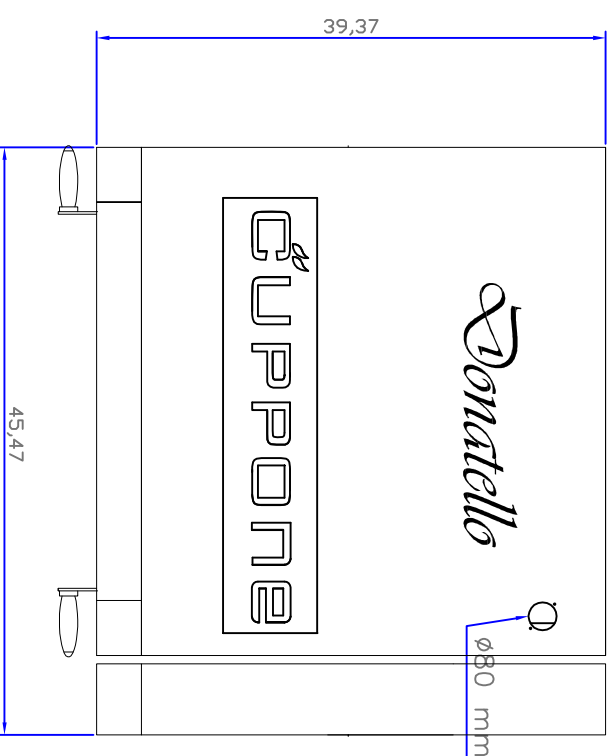

PLANT

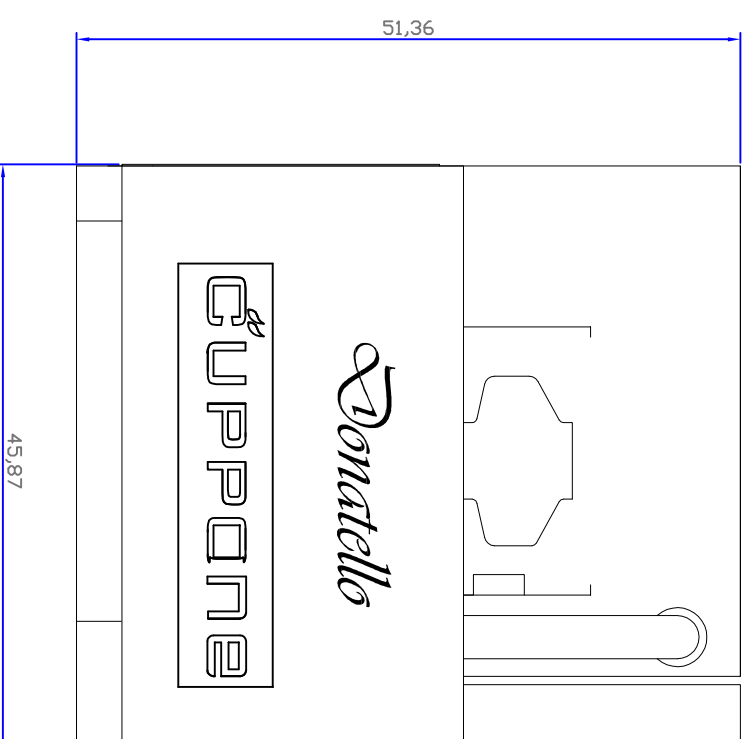

PLANT WITH HOOD

Note: measurement are in inches



Descrizione: Installation plan – Back and plant		Sostituisce il:
Prodotto: Oven series DONATELLO 435/1		Sostituito da:
2		
1		
0	10/04/2014	F.Veronese F.Veronese F.Cuppone Prima emissione
N°	Data	Esecuz. Verifica Approvaz. Descrizione

Note: QUESTO DISEGNO E' DI ESCLUSIVA PROPRIETA' DELLA DITTA CUPPONE F.LLI SRL

Form. orig.:	A3
Scale:	1:10
Dis. N.:	160113AR00
Autore.:	VRN
Nome file:	160113AR00

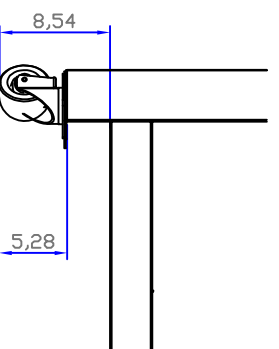
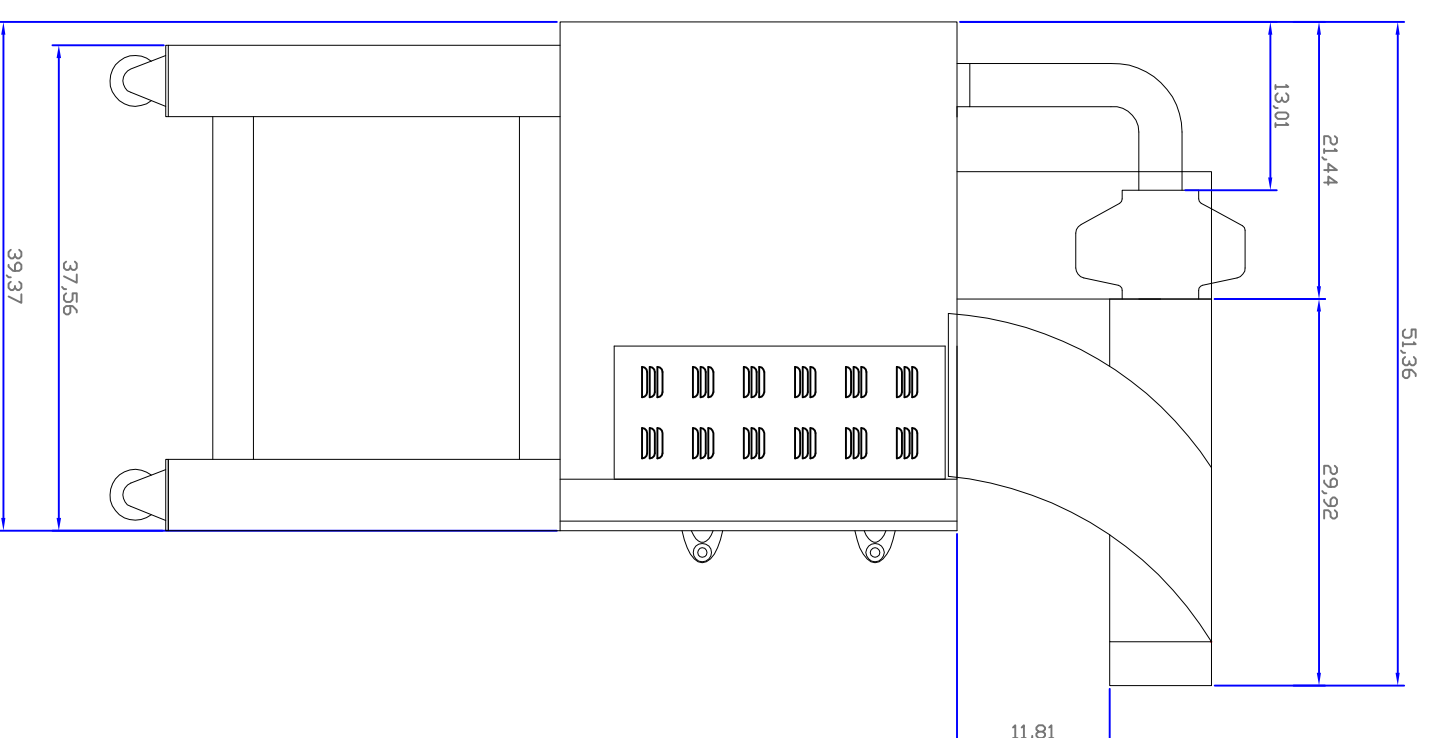
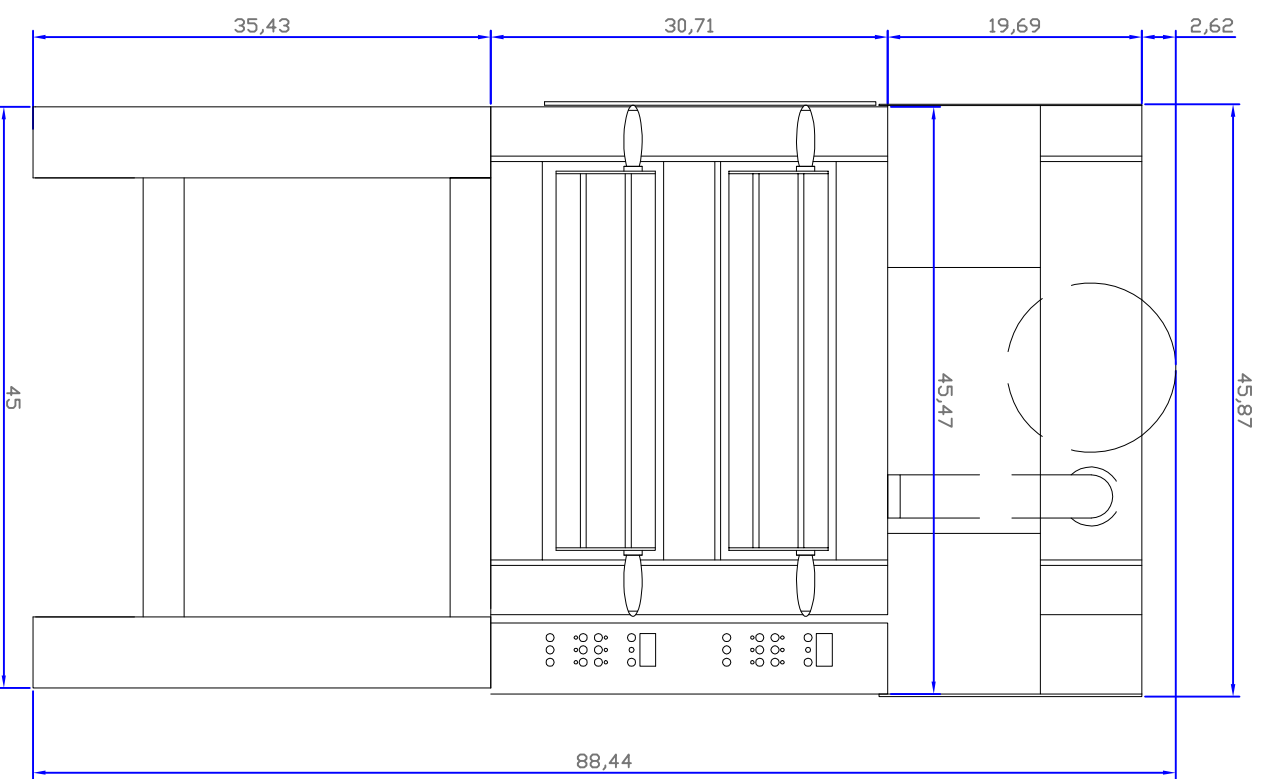

Note: measurement are in inches



Descrizione: Installation plan – Front and side		Sostituisce il:
Produttore: Oven series DONATELLO 435/2		Sostituito da:
N°	Data	Descrizione
0	08/04/2014	F:Veronese F:Veronese F:Cuppone Primo emissione
		Esecuz. Verifica Approvaz.

Note: QUESTO DISEGNO E' DI ESCLUSIVA PROPRIETA' DELLA DITTA CUPPONE F.LLI SRL

Form. orig.:	A3
Scale:	1:10
Dis. N.:	140410BR00
Autore.:	VRN
Nome file:	160113BR00

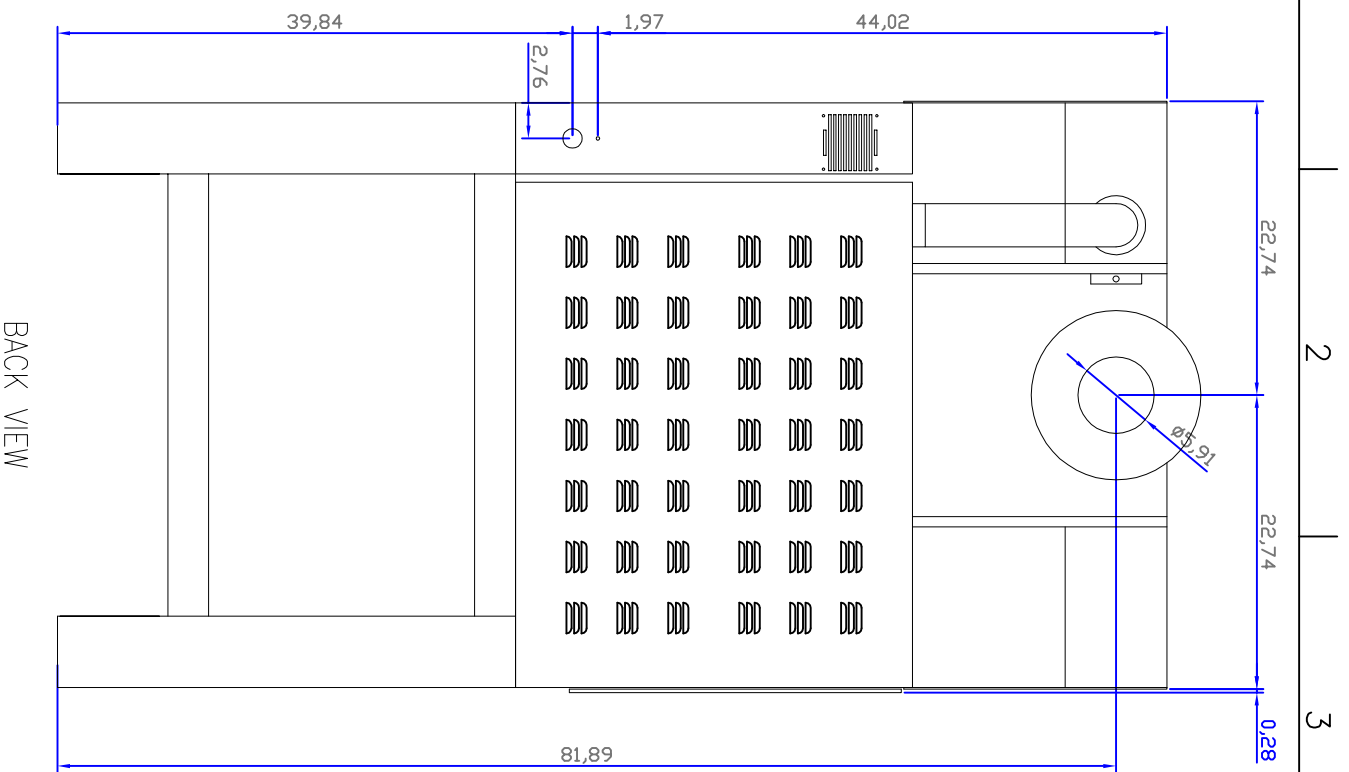

BACK VIEW

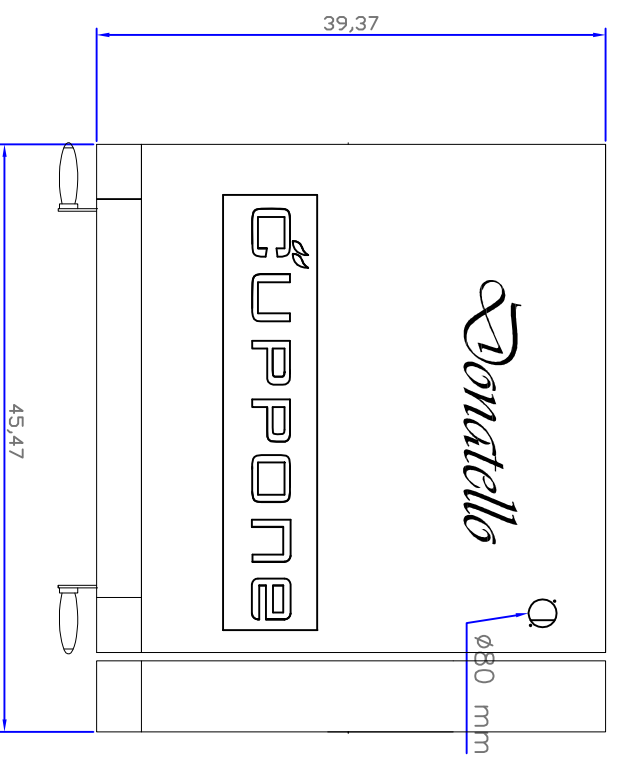

PLANT

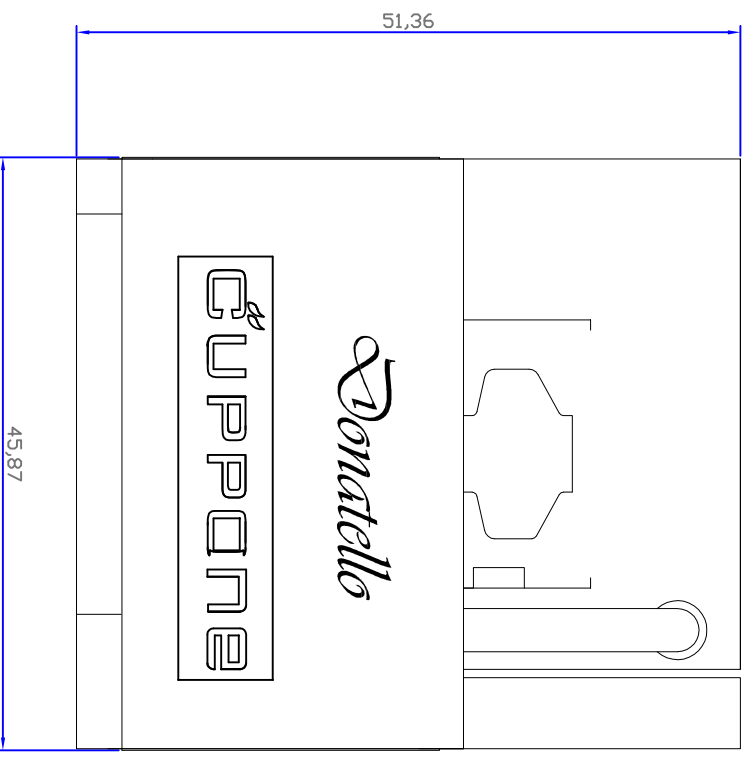

PLANT WITH HOOD

Note: measurement are in inches



Descrizione: Installation plan – Back and plant		Sostituisce il:
Prodotto: Oven series DONATELLO 435/2		Sostituito da:
2		
1		
0	08/04/2014	F.Veronese F.Veronese F.Cuppone
N°	Data	Esecuz. Verifica Approvaz. Prima emissione
Descrizione		

Note: QUESTO DISEGNO E' DI ESCLUSIVA PROPRIETA' DELLA DITTA CUPPONE F.LLI SRL

Form. orig.:	A3
Scale:	1:10
Dis. N.:	140410BR00
Autore.:	VRN
Nome file:	160113BR00

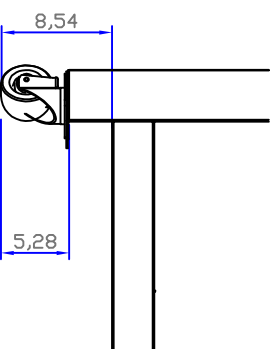
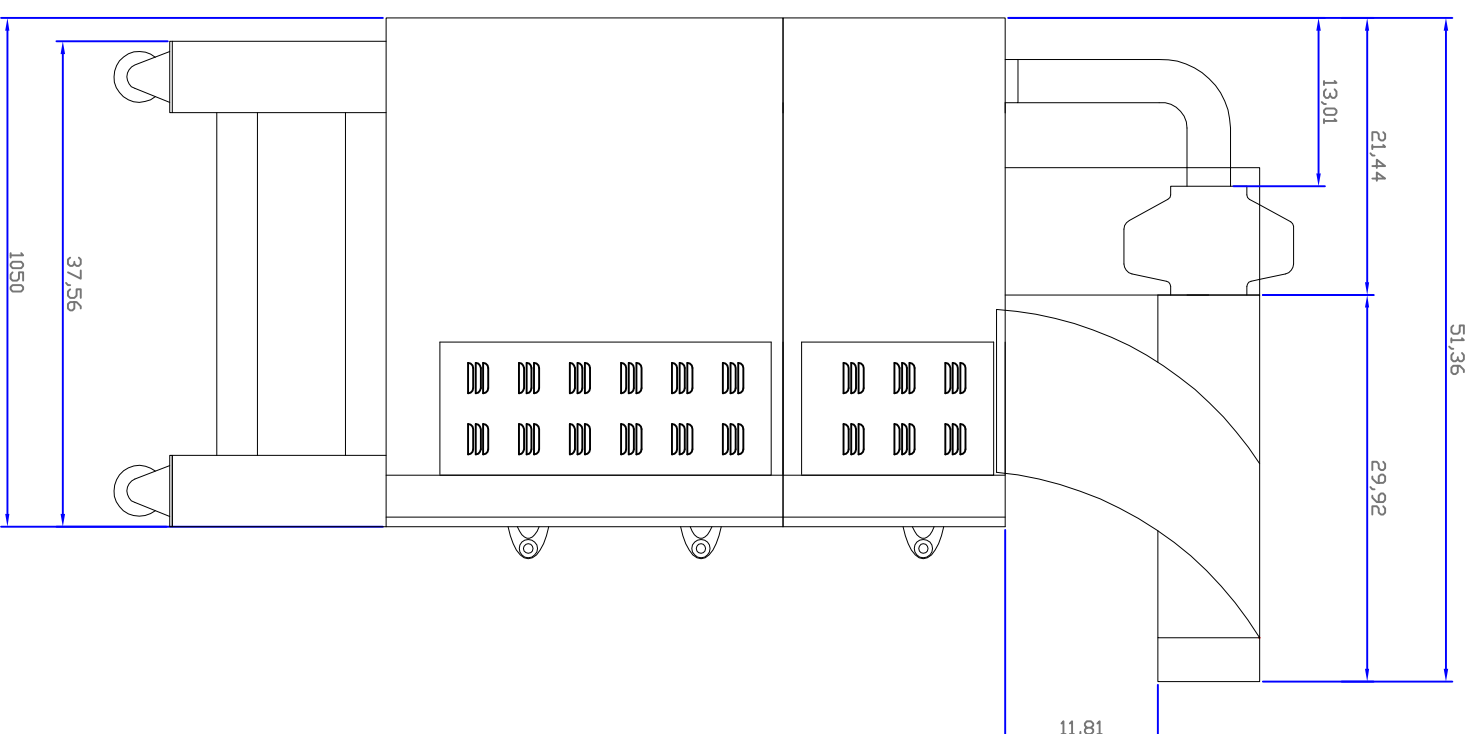
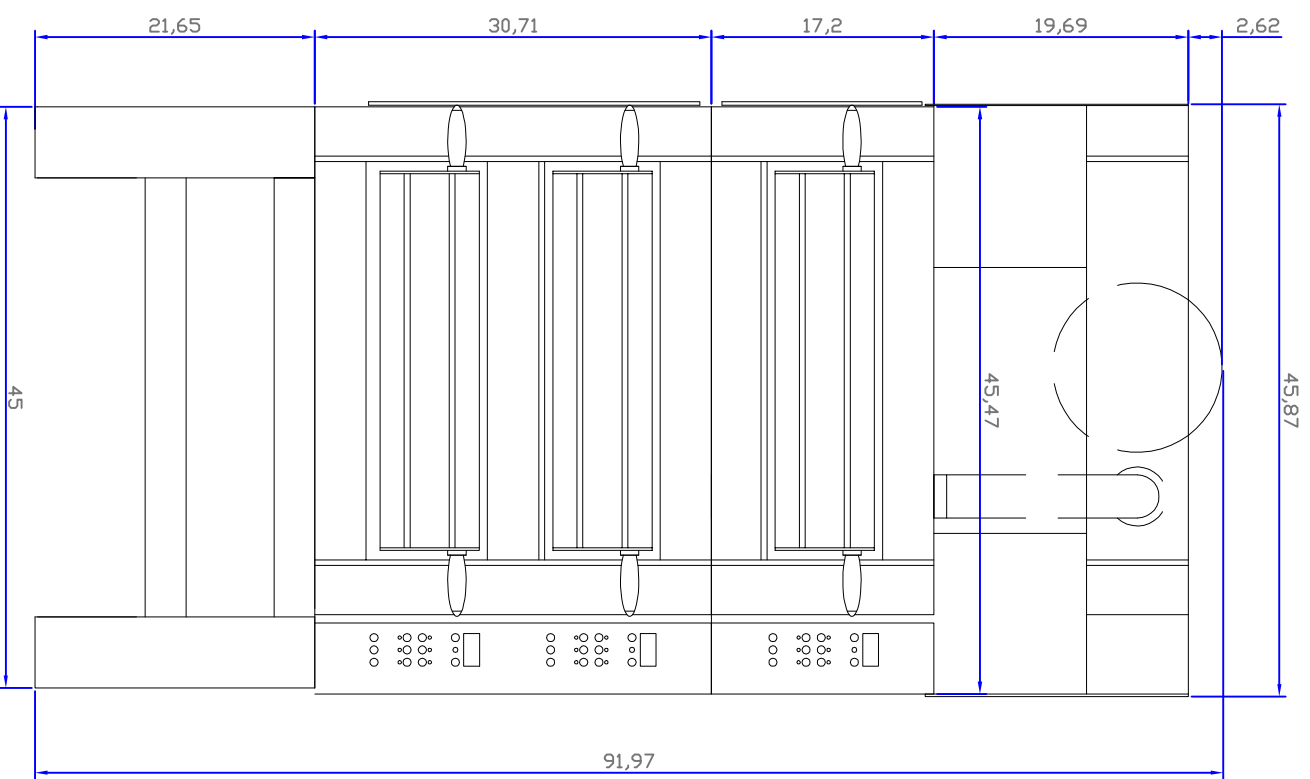

Note: measurement are in inches



Descrizione: Installation plan – Front and side		Sostituisce il:
Produttore: Oven series DONATELLO 435/3		Sostituito da:
N°	Data	Descrizione
1	03/04/2014	F. Veronese
2		F. Cuppone
		Primo emissione
		Verifica
		Approvaz.

Note: QUESTO DISEGNO E' DI ESCLUSIVA PROPRIETA' DELLA DITTA CUPPONE F.LLI SRL

Form. orig.:	A3
Scale:	1:10
Dis. N.:	160113CR00
Autore.:	VRN
Nome file:	140409CR00

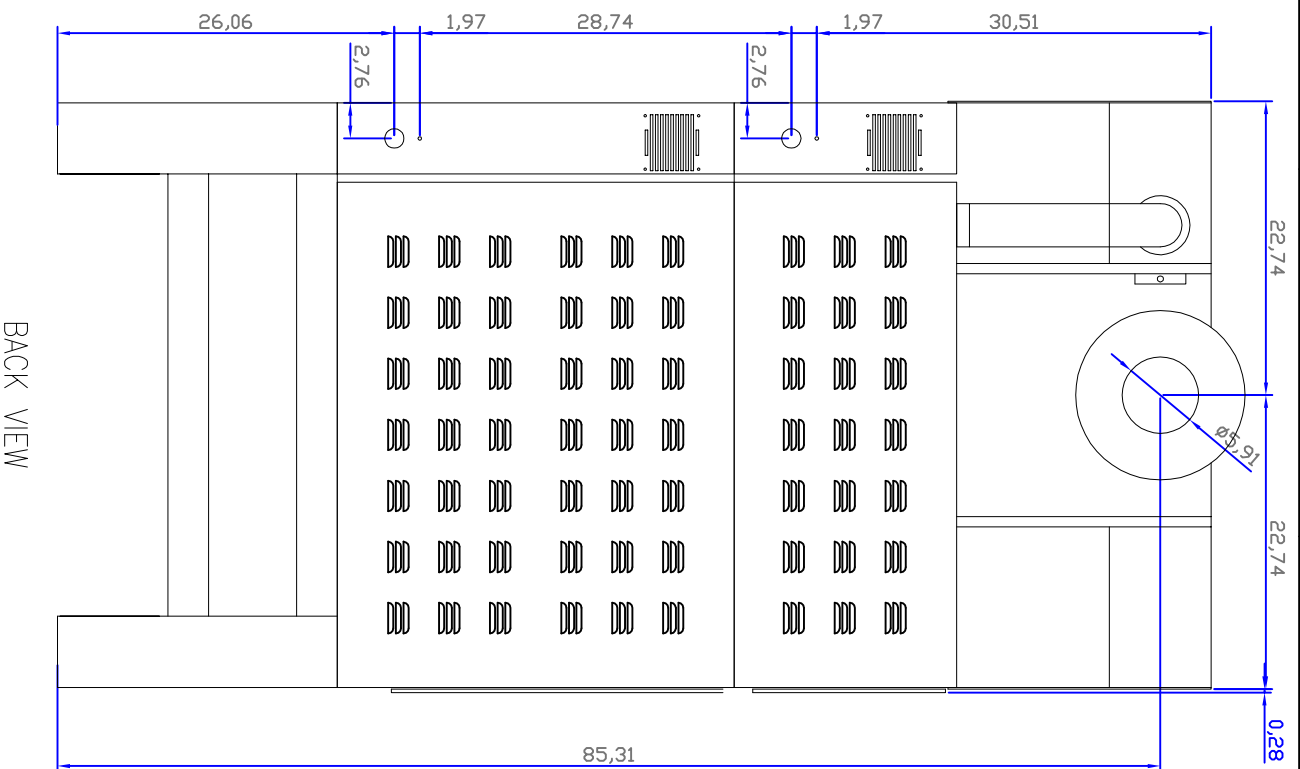

BACK VIEW

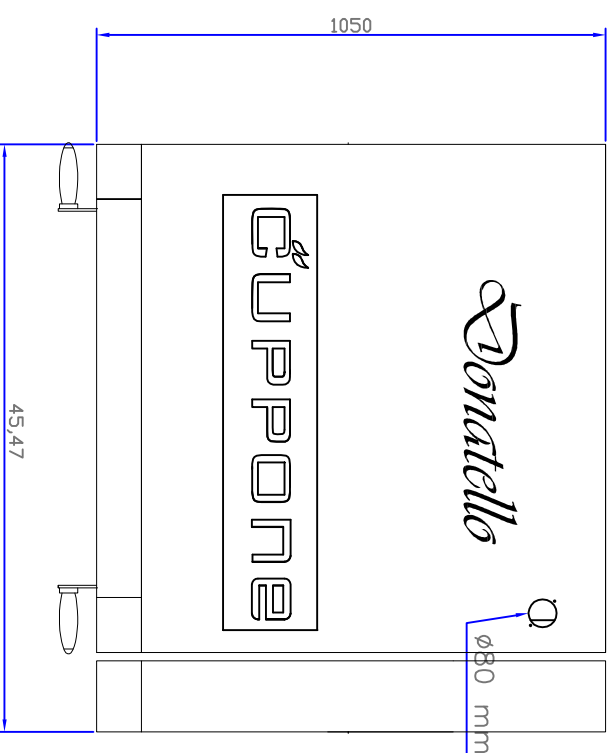

PLANT

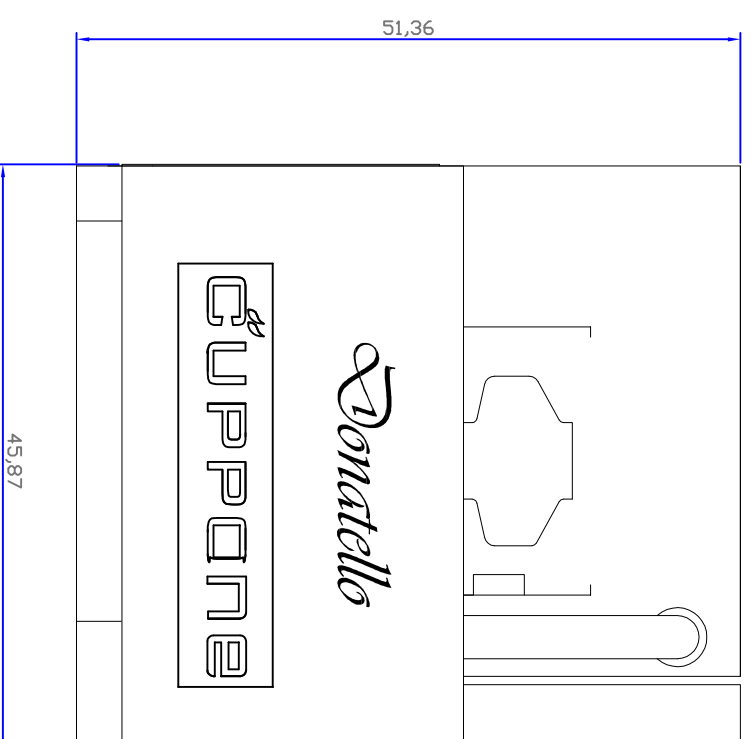

PLANT WITH HOOD

Note: measurement are in inches



Descrizione: Installation plan – Back and plant		Sostituisce il:
Prodotto: Oven series DONATELLO 435/3		Sostituito da:
2		
1		
0	08/04/2014	F. Veronese F. Veronese F. Cuppone
N°	Data	Esecuz. Verifica Approvaz. Prima emissione
		Descrizione

Note: QUESTO DISEGNO E' DI ESCLUSIVA PROPRIETA' DELLA DITTA CUPPONE F.LLI SRL

Form. orig.:	A3
Scale:	1:10
Dis. N.:	160113CR00
Autore.:	VRN
Nome file:	140408CR00